

## KLT-OV5645-Y660B V3.1

### 5MP OmniVision OV5645 MIPI-Schnittstelle Autofokus Kameramodul

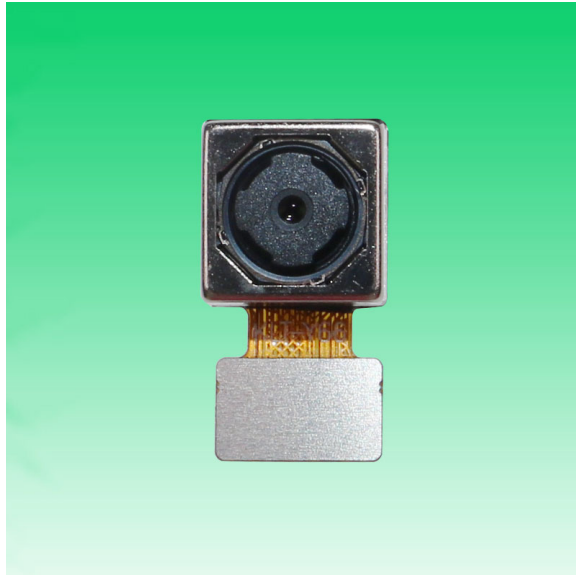

Vorderansicht

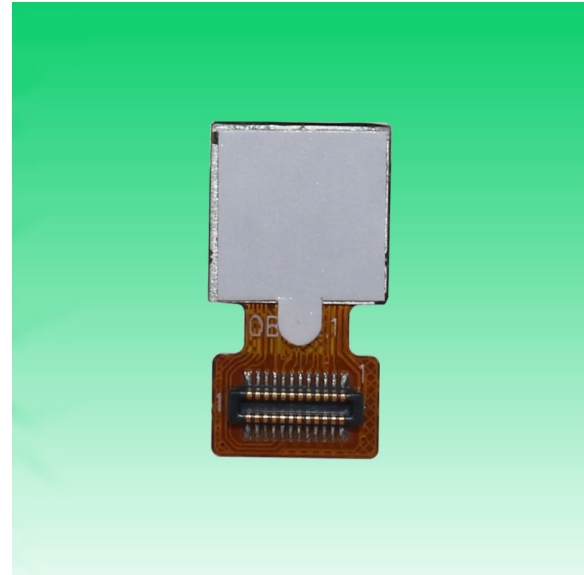

Rückansicht

#### Spezifikationen

<b>Kameramodul Nr.</b>	<b>KLT-OV5645-Y660B V3.1</b>
<b>Auflösung</b>	5MP
<b>Bildsensor</b>	OV5645
<b>Sensorart</b>	1/4"
<b>Pixel Größe</b>	1.4 um x 1.4 um
<b>EFL</b>	3.29 mm
<b>F.NO</b>	2.80
<b>Pixel</b>	2592 x 1944
<b>Betrachtungswinkel</b>	68.7°(DFOV) 58.1°(HFOV) 45.0°(VFOV)
<b>Linsenabmessungen</b>	8.50 x 8.50 x 5.17 mm
<b>Modulgröße</b>	15.90 x 8.50 mm
<b>Modultyp</b>	Autofokus
<b>Schnittstelle</b>	MIPI
<b>Autofokus-VCM-Treiber-IC</b>	Eingebettet
<b>Linsenmodell</b>	KLT-LENS-M5101
<b>Linsentyp</b>	650 nm IR-Schnitt
<b>Betriebstemperatur</b>	-30°C to +70°C
<b>Gegenstecker</b>	BBR43-24KB533

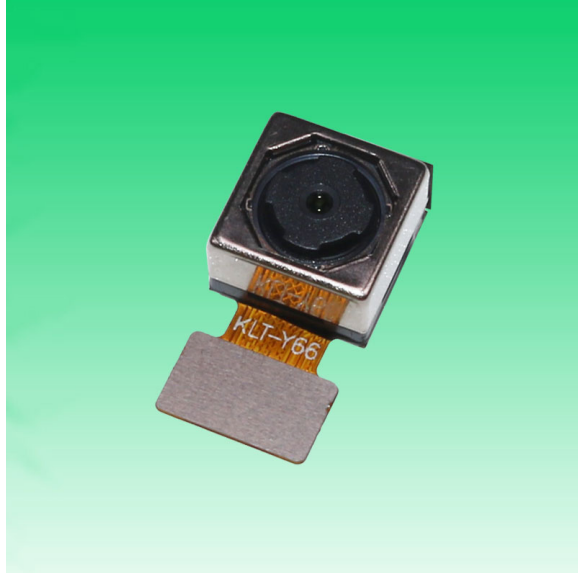
**KLT-OV5645-Y660B V3.1****5MP OmniVision OV5645 MIPI-Schnittstelle Autofokus Kameramodul**

Ansicht von oben



Seitenansicht

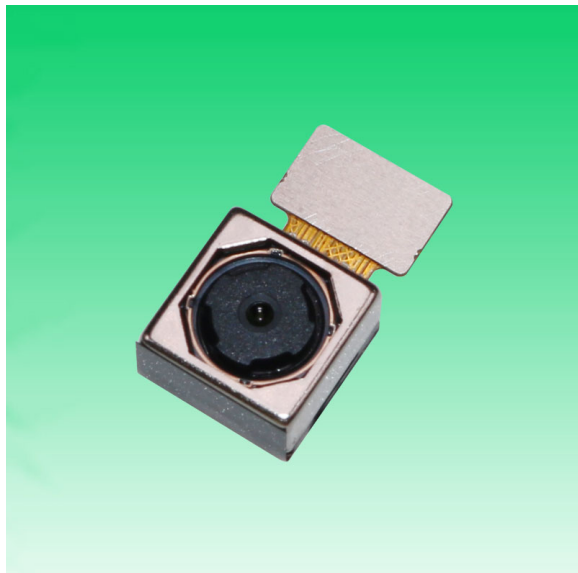

Untersicht



Gegenstecker



*your BEST camera module partner*

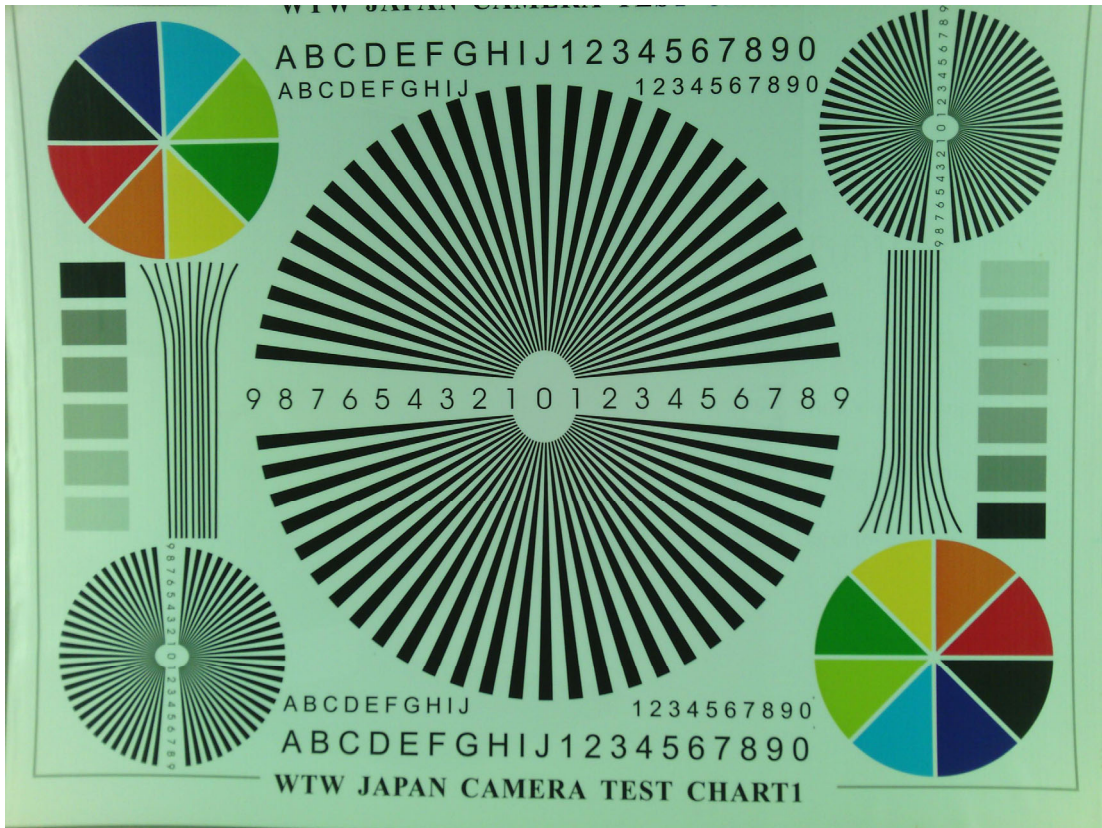
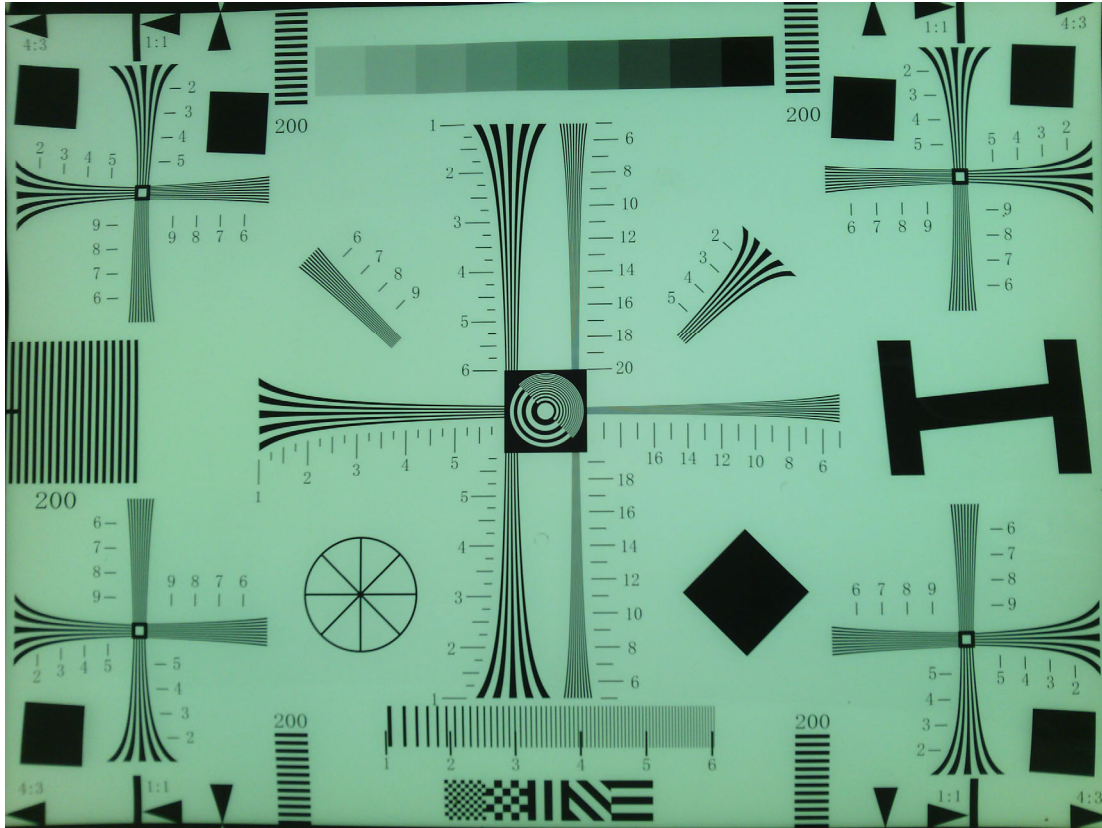

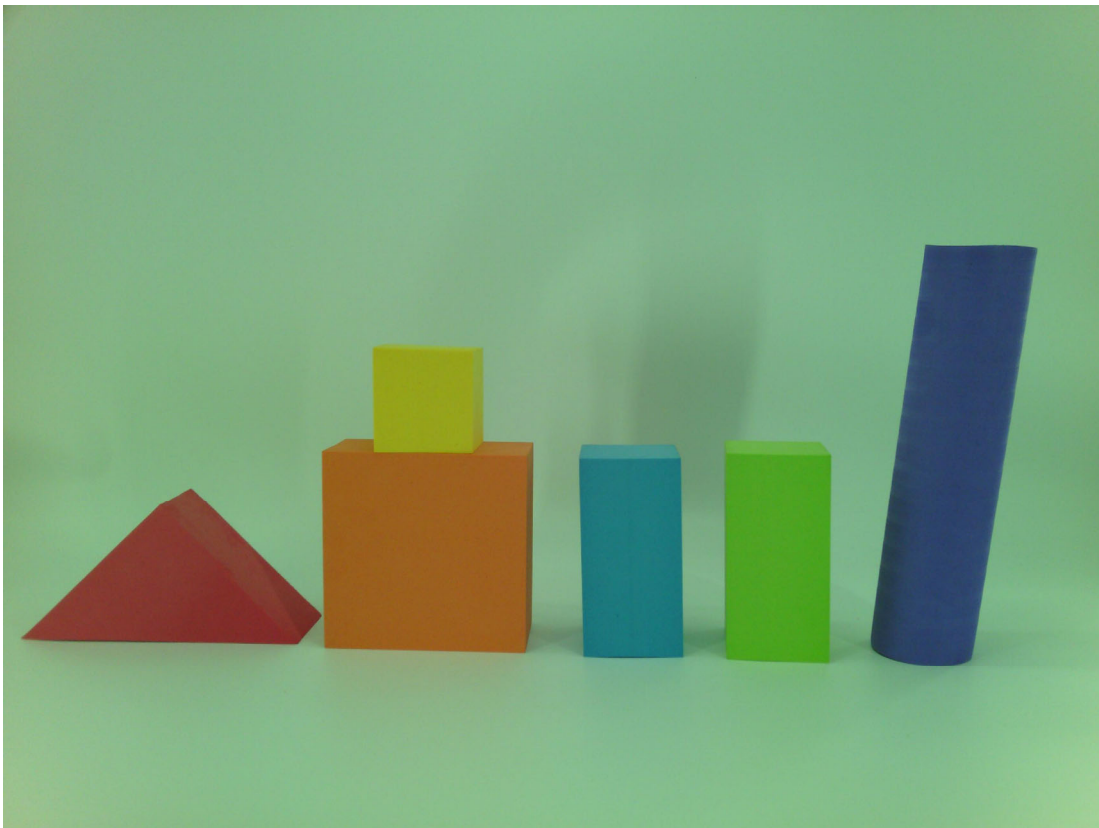



### Periodic table of Elements



**Legend:**

- Hydrogen (Gas)
- Alkali Metals
- Alkaline Earth Metals
- Transition Metals
- Other Metals
- Metalloids
- Non-metals
- Halogens
- Noble Gases
- Lanthanides
- Actinides

**Average Atomic Mass** (Li: 6.941)  
**Atomic Number** (Li: 3)  
**Name** (Li: Lithium)  
**Symbol** (Li: Li)

1	1,008	H	Hydrogen	1	4,002	He	Helium
2	6,941	Li	Lithium	4	9,01	Be	Beryllium
3	22,99	Na	Sodium	12	24,31	Mg	Magnesium
4	39,09	K	Potassium	20	40,08	Ca	Calcium
5	85,47	Rb	Rubidium	38	87,62	Sr	Strontium
6	132,9	Cs	Cesium	56	137,3	Ba	Barium
7	223	Fr	Francium	88	226	Ra	Radium
8	1,008	H	Hydrogen	10	20,18	Ne	Neon
9	18,99	F	Fluorine	18	35,45	Ar	Argon
10	39,95	Cl	Chlorine	36	79,90	Kr	Krypton
11	83,80	Br	Bromine	54	131,3	Xe	Xenon
12	222	Rn	Radon	86	222	Og	Oganesson
13	10,81	B	Boron	14	12,01	C	Carbon
14	26,98	Al	Aluminum	15	28,08	Si	Silicon
15	69,72	Ga	Gallium	16	30,97	P	Phosphorus
16	72,61	Ge	Germanium	17	32,07	S	Sulfur
17	74,92	As	Arsenic	34	78,96	Se	Selenium
18	121,8	Sb	Antimony	52	127,6	Te	Tellurium
19	158,9	Er	Erbium	80	158,9	Tm	Thulium
20	167,2	Ho	Holmium	68	167,2	Er	Erbium
21	168,9	Tm	Thulium	69	168,9	Yb	Ytterbium
22	173	Lu	Lutetium	70	173	Lu	Lutetium
23	174,9	Lr	Lawrencium	103	260	Lr	Lawrencium



**ROHS**

PIN NO	NAME
1	MCLK
2	PWDN
3	GND
4	DATAN0
5	DATAP0
6	CLKN
7	CLKP
8	GND
9	IOVDD(1.8V)
10	AVDD(2.8V)
11	GND
12	RESET
13	SCL
14	SDA
15	GND
16	DATAN1
17	DATAP1
18	AGND
19	NC
20	NC
21	NC
22	DVDD(1.5V)
23	AFVDD(2.8V)
24	NC

焦距 (EFL)	3.29
光圈 (F.NO)	2.8
视场角 (View Angle)	68.7°
畸变 (Distortion)	< 1%
镜头类型 (Lens Size)	1/4 inch
像素 (Array Size)	2592*1944
感光芯片 (Chip Type)	OV5645

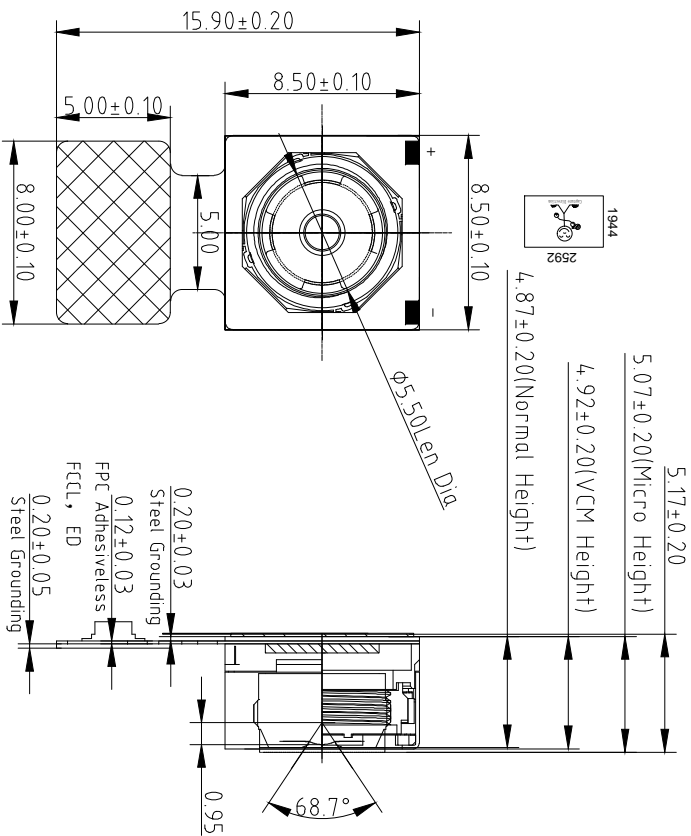

**TOP VIEW**

**SIDE VIEW**

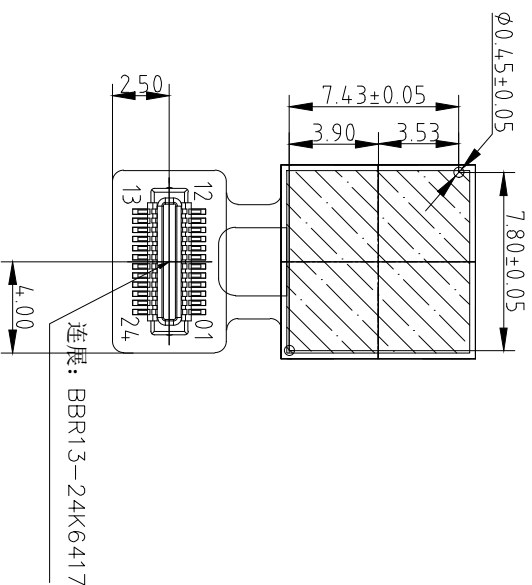

**BOTTOM VIEW**

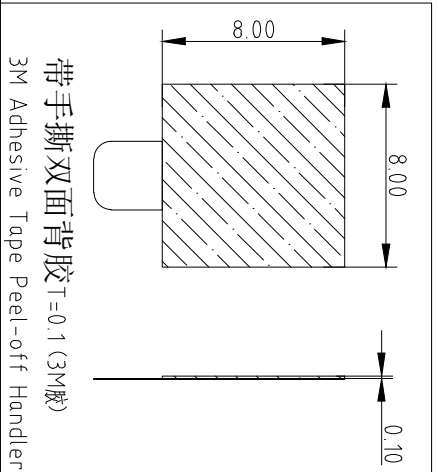

带手撕双面背胶 T=0.1 (3M胶)  
3M Adhesive Tape Peel-off Handler

产品变更	详细变更事项
(1)	
(2)	
(3)	

1/0	All	First Release	Kevin	2017-08-11
REV.	Zone	Description	Approved	Date
<b>佳立数码(深圳)有限公司</b> Kai Lap Technologies Group Ltd				
Designed By: Kevin		Client Name: Y660		
Checked By: Feng Liu		Model Name: KLT-OV5645-Y660B V3.1		
Approved By: Aouly_Yan		Projection Type: Third Angle		
		Unit: mm	Material: -----	
		Scale: 1:1	Sheet: 1 of 1	Version: 1/0



Lens Model: KLT-LENS-M5101

SPECIFICATION		
1. SENSOR SIZE	1/4" (5M CSP)	
2. MAX IMAGE CIRCLE	24.90mm	
3. TOTAL TRACK	4.18±0.1mm	
4. BFL	3.29mm	
5. OPTICAL BFL	1.43mm	
6. MECHANICAL BFL	0.85mm	
7. F/NO	2.8±5%	
8. VIEW OR FIELD DIAGONAL	VERTICAL	45.0° (V=1.38)
	HORIZONTAL	58.1° (H=1.814)
	DIAGONAL	68.7° (D=2.268)
9. OPTICAL DISTORTION	<1.0%	
10. TV DISTORTION	<1.0%	
11. RELATIVE ILLUMINATION	>42.3%	
12. CONSTRUCTION	4P+IR FILTER	
13. CHIEF RAY ANGLE	<25°	
14. CUT FREQUENCY AT 50%	650±10nm	
15. THREAD	M6.0X0.35P	
16. IMAGE QUALITY	AXIS	330Lp/mm
	0.7Y	200Lp/mm
17. APPEARANCE QUALITY (Scratch/Dig)	CENTER	20/10
	EDGE	40/20

NO	MODIFY CONTENT	NAME	DATE
4			
3			
2			
1			

ANGLE	RANGE	DIM	UNIT	MATERIAL	SCALE
	ANGLE	±0.5°			8 : 1
	ANGLE	±0.010			
	ANGLE	±0.05			
	ANGLE	±0.1			

  

**NOTE:**

1. 镜头表面不可有油污、灰尘、毛丝等异物。
2. 镜头配VCM锁附高度为 4.7±0.1mm, 扭力为20--60gf.cm。
3. 镜头承受推力为≥2.0kg。
4. 镜头品质参数需符合图中要求。

1 2 3 4 5 6 7 8

REV.	EC#	DESCRIPTION	DATE	DRAWN	CHECKED	APPROVED
A	TJECR10018-02	NEW RELEASE PER NPRI 0009	11/05/10'	RAIN	DICK, SON	HARDWARE
B	TJECR13014	AXI, AXI	05/13/13'	RAIN	Steve M	eng
						Jeff

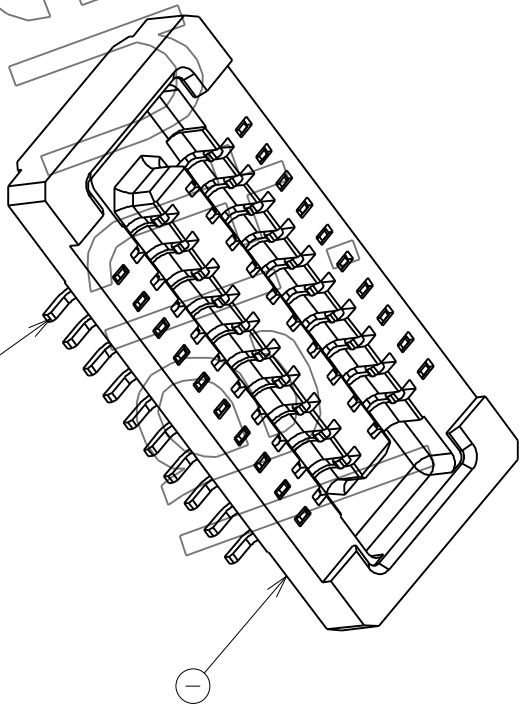
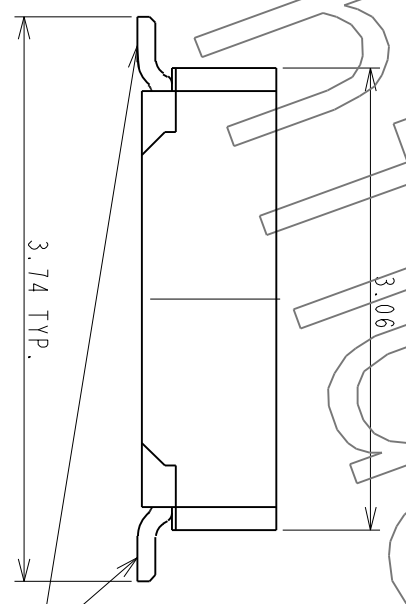
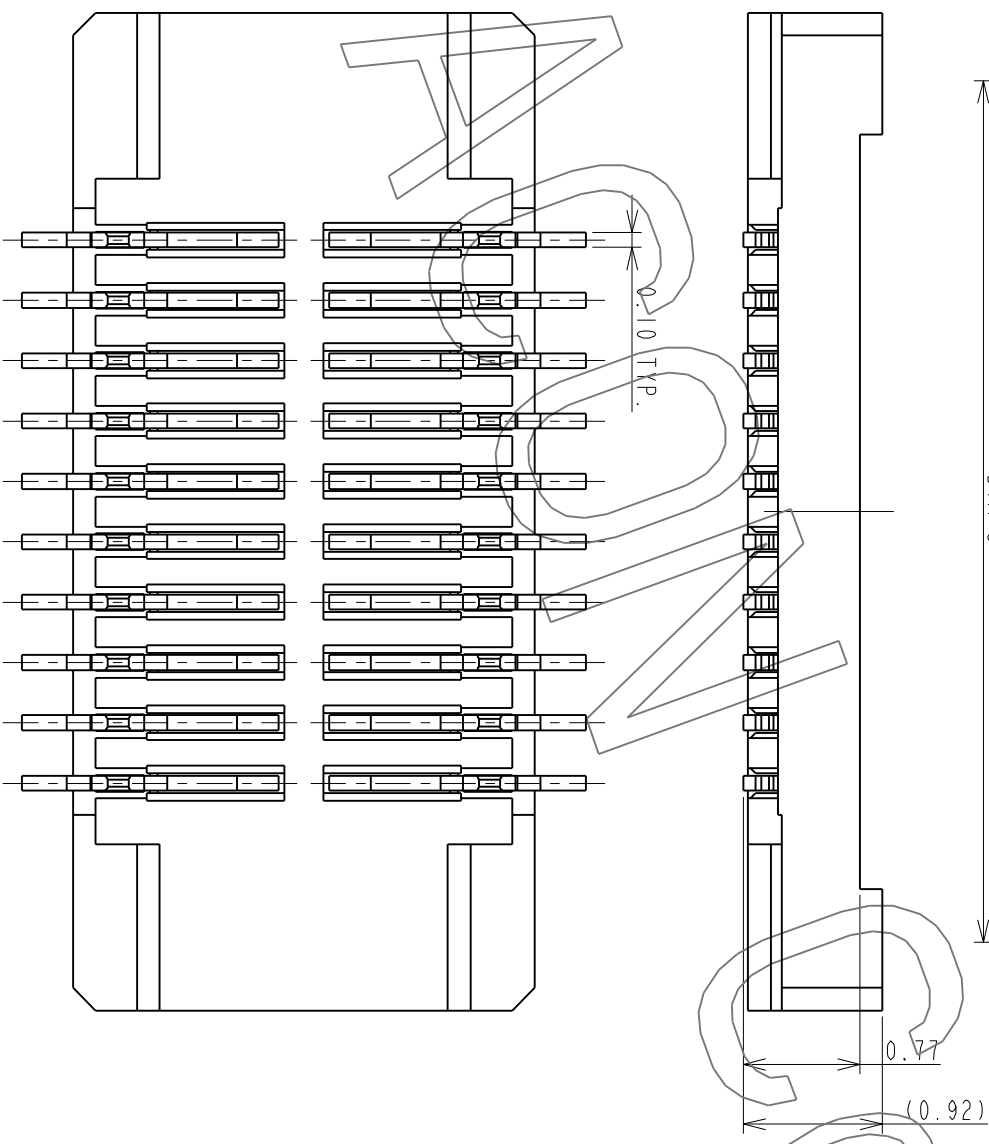
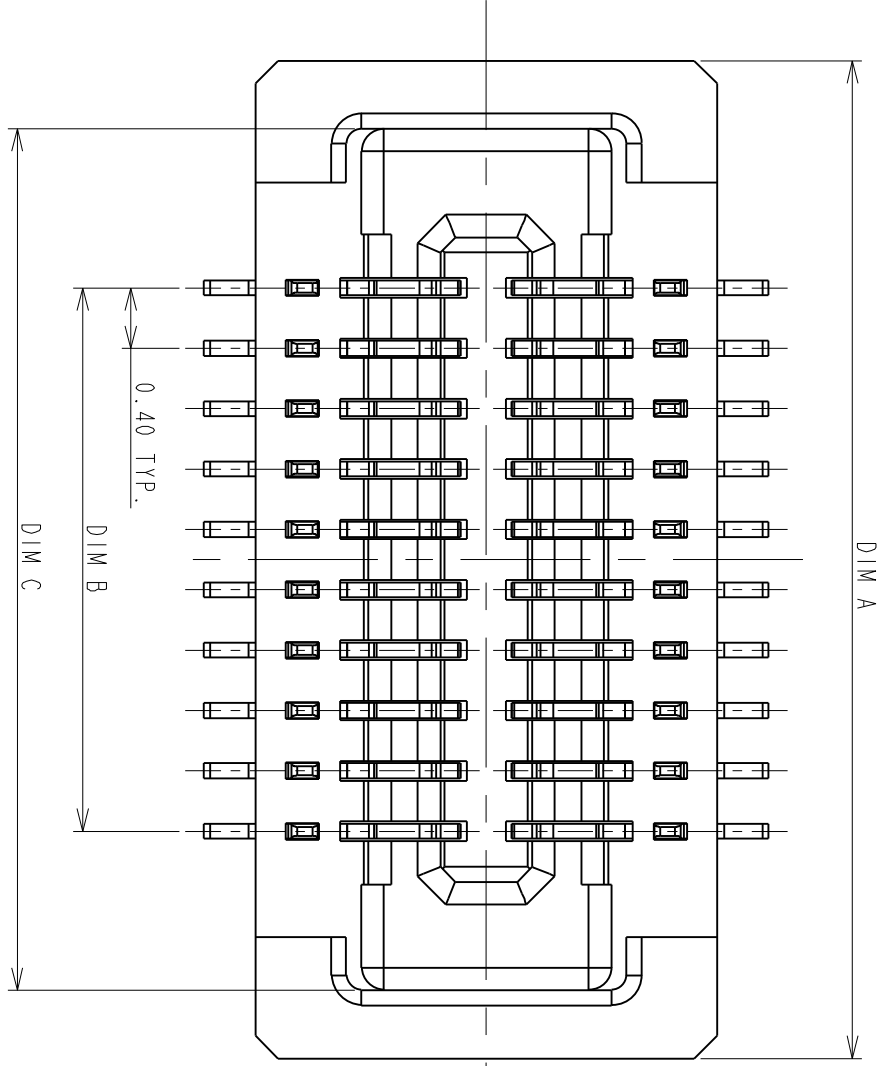

0.08  
ALL OF PLACES

ITEM	NAME	Q'TY	PART #	MATERIAL / FINISH
2	CONTACT	XX	T-BBR43-100X30	COPPER ALLOY/PLATING GOLD
1	HOUSING	1	I-BBR43-1XXX33	HIGH TEMP RESIN/UL 94 V-0

TOLERANCES UNLESS OTHERWISE SPECIFIED		DATE	
GENERAL	.XX	RAIN	04/15/10'
ANGLES	.XX	DESIGN	04/15/10'
	.XX	CHECKED	04/24/10'
	.XX	HARDWARE	04/24/10'
	.XX	APPROVED	04/24/10'
	.XX	DICK, LEE	04/24/10'

SCALE	20:1	TITLE	P0.4*H1.0mm BOARD TO BOARD CONN. RECEPTACLE WITHOUT HOLD DOWN
SHEET	1 OF 2	SERIES	BBR
UNIT	MM	DWG NO.	C-BBR43-04-01
		REV.	B



This document and information contained herein are the property of Advanced Connectek Inc. Copies are issued in strict confidence and shall not be reproduced or copied, or used as the basis of manufacture or sale of apparatus without permission.

All materials meet the ACON's spec. environment-related substances management technical standard

F E D C B A

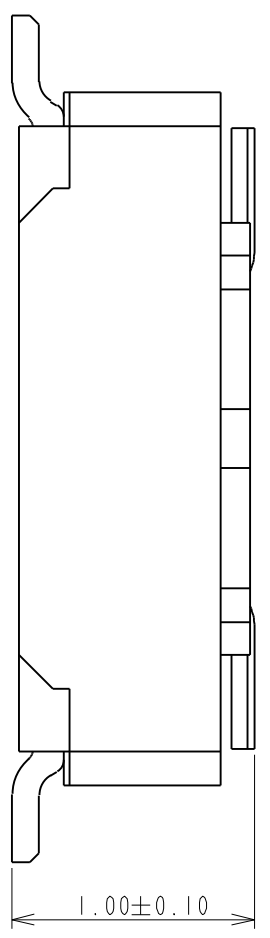

PRODUCT NUMBERING CODE:  
 BBR43 - XX K X 5 X X  
 1 2 3 4 5 6 7

1. PRODUCTION CODE:  
 BBR43: BOARD TO BOARD 0.4 PITCH RECEPTACLE

2. POSITIONS:  
 XX: POSITIONS(SEE TABLE A)

3. INSULATOR COLOR:  
 K: BLACK

4. CONTACT PLATING:  
 1: GOLD 10u" MIN  
 2: GOLD 5u" MIN  
 3: GOLD 10u" MIN  
 B: GOLD 4u" MIN FOR SPOT PLATING  
 ALL OVER: NI 50~100u"

5. TYPE OF HEIGHT:  
 5: H=0.77mm

6. TYPE OF HOLD DOWN:  
 3: WITHOUT HOLD DOWN

7. OTHER  
 2: WITH POST, FINISHED PRODUCTS  
 3: WITHOUT POST, FINISHED PRODUCTS

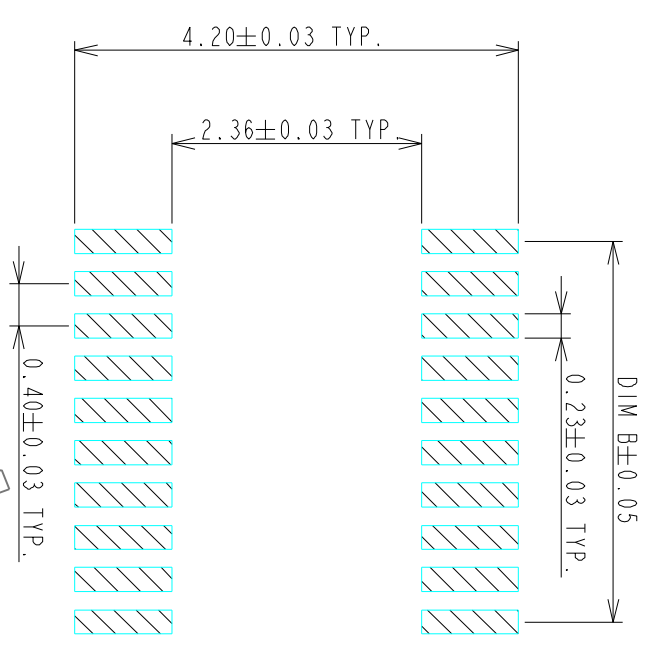

RECOMMENDED P.C. BOARD PATTERN DIMENSION (WITHOUT HOLD DOWN)

NOTES:  
 1.0: RATING  
 1.1: VOLTAGE: 60V AC/DC  
 1.2: CURRENT: 0.5 AMPS  
 1.3: OPERATION TEMPERATURE: -40°C TO +85°C  
 2.0: ELECTRICAL CHARACTERISTIC:  
 2.1: CONTACT RESISTANCE: 50 mΩ MAX INITIAL  
 2.2: INSULATION RESISTANCE: 1000 MΩ MIN INITIAL  
 2.3: DIELECTRIC WITHSTANDING VOLTAGE: 250V AC FOR ONE MINUTE  
 3.0 TOLERANCES UNLESS OTHERWISE SPECIFIED  
 GENERAL: DIMENSION >10.00 ±0.13  
 DIMENSION 5.00~10.00 ±0.10  
 DIMENSION <5.00 ±0.05

4.0 ALL COPPLANARITY IS 0.08mm MAX. BEFORE REFLOW  
 ALL COPPLANARITY IS 0.10mm MAX. AFTER REFLOW

POSITIONS	DIM A	DIM B	DIM C
10	4.61	1.60	3.71
14	5.41	2.40	4.51
16	5.81	2.80	4.91
18	6.21	3.20	5.31
20	6.61	3.60	5.71
22	7.01	4.00	6.11
24	7.41	4.40	6.51
26	7.81	4.80	6.91
30	8.61	5.60	7.71
32	9.01	6.00	8.11
34	9.41	6.40	8.51
40	10.61	7.60	9.71
44	11.41	8.4	10.51
48	12.21	9.20	11.31
50	12.61	9.60	11.71
54	13.41	10.40	12.51
60	14.61	11.60	13.71
70	16.61	13.60	15.71
80	18.61	15.60	17.71

TABLE A:

TOLERANCES UNLESS OTHERWISE SPECIFIED		DRAWN		DATE	
GENERAL X	±0.38	RAIN	04/15/10		
XX	±0.13	DESIGN			
ANGLES X°	±3.0°	RAIN	04/15/10		
SCALE	20:1	CHECKED			
SHEET	2 OF 2	HARDWARE	04/24/10		
UNIT	MM	APPROVED			
		DICK. LEE	04/24/10		
		<b>CUSTOMER DRAWING</b>		TITLE	
				P0.4*H1.0mm BOARD TO BOARD	
				CONN. RECEPTACLE	
				WITHOUT HOLD DOWN	
		SERIES		SIZE	
		BBR		A3	
		DWG NO. C-BBR43-04-01		REV. B	

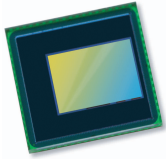

# OV5645 5-megapixel product brief



## High Quality 5-Megapixel Photography and HD Video for Low-Cost Mobile Devices



available in  
a lead-free  
package

OmniVision's OV5645 is a high performance, 5-megapixel system-on-chip (SOC) ideally suited for the cost-sensitive segment of the mobile handset market. The CameraChip™ sensor's single MIPI port replaces both a bandwidth-limited DVP interface and a costly embedded JPEG compressor, allowing the new OV5645 sensor to save significant silicon area and cost. An embedded autofocus control with voice coil motor driver offers further cost savings for the end user, making the OV5645 a highly attractive alternative to other 5-megapixel sensors currently on the market.

The OV5645 also features a new picture-in-picture (PIP) architecture that offers an easy-to-implement, low-cost dual camera system solution for mobile handsets and smartphones. The feature is based on a master/slave configuration where a front-facing camera (OV7965) can be connected through the OV5645 master camera, enabling a two-camera system with PIP functionality without the need for an additional MIPI interface into the baseband processor.

Built on OmniVision's 1.4-micron OmniBSI™ pixel architecture, the OV5645 offers high performance 5-megapixel photography and 720p HD video at 60 frames per second (FPS) and 1080p HD video at 30 FPS with complete user control over formatting and output data transfer. The sensor's 720p HD video is captured in full field-of-view with 2 x 2 binning, which doubles the sensitivity and improves the signal-to-noise ratio (SNR). A unique post-binning, re-sampling filter function removes zigzag artifacts around slant edges and minimizes spatial artifacts to deliver even sharper, crisper color images.

Find out more at [www.ovt.com](http://www.ovt.com).

## Applications

- Cellular Phones
- PC Multimedia
- Toys
- Digital Still Cameras

## Product Features

- 1.4  $\mu\text{m}$  x 1.4  $\mu\text{m}$  pixel with OmniBSI+™ technology for high performance (high sensitivity, low crosstalk, low noise, improved quantum efficiency)
- optical size of 1/4"
- automatic image control functions: automatic exposure control (AEC), automatic white balance (AWB), automatic band filter (ABF), automatic 50/60 Hz luminance detection, and automatic blacklevel calibration (ABLC)
- image quality controls: color saturation, hue, gamma, sharpness (edge enhancement), lens correction, defective pixel canceling, and noise canceling
- support for output formats: RAW RGB, RGB565/555/444, YUV422/420, YCbCr422
- support for video or snapshot operations
- support for internal and external frame synchronization for frame exposure mode
- support for LED and flash strobe mode
- support for horizontal and vertical sub-sampling, binning
- support for minimizing artifacts on binned image
- support for data compression output
- support for anti-shake
- standard serial SCCB interface
- dual lane MIPI output interface
- embedded 1.5V regulator for core power
- programmable I/O drive capability, I/O tri-state configurability
- support for black sun cancellation
- support for images sizes: 5 megapixel, and any arbitrary size scaling down from 5 megapixel
- support for auto focus control (AFC) with embedded AF VCM driver
- embedded microcontroller
- suitable for module size of 8.5 x 8.5 x <math>\pm 6\text{mm}</math> with both CSP and RW packaging

# OV5645

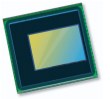

## Ordering Information

- OV05645-A66A (color, lead-free, 66-pin CSP3)
- OV05645-G04A (color, chip probing, 200  $\mu\text{m}$  backgrinding, reconstructed wafer)

## Product Specifications

- active array size: 2592 x 1944
- power supply:
  - core: 1.5V  $\pm 5\%$  (with embedded 1.5 regulator)
  - analog: 2.6 - 3.0V (2.8V typical)
  - I/O: 1.8V / 2.8V
- temperature range:
  - operating: -30°C to 70°C junction temperature
  - stable image: 0°C to 50°C junction temperature
- output formats: 8-/10-bit RGB RAW, RGB565/555/444, YUV422/420, YCbCr422 output
- lens size: 1/4"
- lens chief ray angle: 29.1°
- input clock frequency: 6 - 27 MHz
- max S/N ratio: 36 dB
- maximum image transfer rate:
  - QSXGA (2592X1944): 15 fps
  - 1080p: 30 fps
  - 1280x960: 45 fps
  - 720p: 60 fps
- shutter: rolling shutter / frame exposure
- maximum exposure interval: 1964 x  $t_{\text{row}}$
- pixel size: 1.4  $\mu\text{m}$  x 1.4  $\mu\text{m}$
- image area: 3673.6  $\mu\text{m}$  x 2738.4  $\mu\text{m}$
- package/die dimensions:
  - CSP3: 6200  $\mu\text{m}$  x 4860  $\mu\text{m}$
  - COB: 6190  $\mu\text{m}$  x 4850  $\mu\text{m}$

## Functional Block Diagram

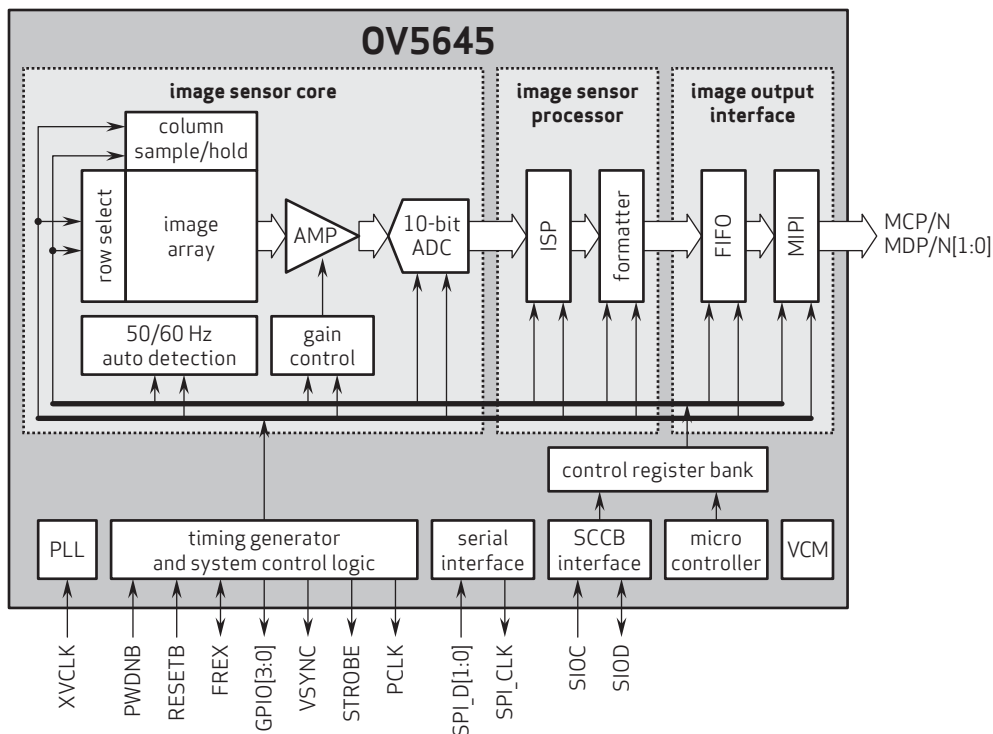

4275 Burton Drive  
Santa Clara, CA 95054  
USA

Tel: + 1 408 567 3000  
Fax: + 1 408 567 3001  
www.ovt.com

OmniVision reserves the right to make changes to their products or to discontinue any product or service without further notice. OmniVision, the OmniVision logo and OmniPixel are registered trademarks of OmniVision Technologies, Inc. OmniBSI+ is a trademark of OmniVision Technologies, Inc. All other trademarks are the property of their respective owners.

OmniVision



Kameraanwendungen

*your BEST camera module partner*



Autopilot



Live-Streaming



Videokonferenz



Biometrische Eye-Tracker-Erkennung



Maschinelles Sehen



Agrarmonitor



Nachtsichtsicherheit



Drohnen- und Sport-Adleraugen



Interaktive Haustierkamera

[www.KaiLapTech.com](http://www.KaiLapTech.com) [sales@KaiLapTech.com](mailto:sales@KaiLapTech.com) Tel: (852) 6908 1256 Fax: (852) 3017 6778



your BEST camera module partner

## Kameraanwendungen



### IMAGING DEVICES





Referenztable für die Pinbelegungsdefinition des Kameramoduls

OmniVision Sony Himax Samsung On-Semi Aptina Himax GalaxyCore PixArt Bildsensoren	
Pin Signal	Beschreibung
DGND GND	Masse für digitale Schaltung
AGND	Masse für analoge Schaltung
PCLK DCK	DVP-PCLK-Ausgang
XCLR PWDN XSHUTDOWN STANDBY	Abschalten aktiv hoch mit internem Pulldown-Widerstand
MCLK XVCLK XCLK INCK	Systemeingangsuhr
RESET RST	Aktiv Low mit internem Pull-up-Widerstand zurücksetzen
NC NULL	keine Verbindung
SDA SIO_D SIOD	SCCB-Daten
SCL SIO_C SOIC	SCCB-Eingangstakt
VSYNC XVS FSYNC	DVP-VSYNC-Ausgang
HREF XHS	DVP-HREF-Ausgang
DOVDD	Strom für E/A-Schaltung
AFVDD	Strom für VCM-Schaltung
AVDD	Strom für analoge Schaltung
DVDD	Strom für digitale Schaltung
STROBE FSTROBE	Strobe-Ausgang
FSIN	Synchronisieren Sie das VSYNC-Signal vom anderen Sensor
SID	SCCB letzte Bit-ID-Eingabe
ILPWM	mechanische Shutter-Ausgangsanzeige
FREX	Rahmenbelichtung / mechanischer Verschluss
GPIO	Allzweckeingänge
SLASEL	I2C-Slave-Adresse auswählen
AFEN	CEN-Chip aktivieren aktiv hoch auf VCM-Treiber-IC
<b>MIPI Schnittstelle</b>	
MDN0 DN0 MD0N DATA_N DMO1N	MIPI 1st negative Ausgabe der Datenspur
MDP0 DP0 MD0P DATA_P DMO1P	MIPI 1st positiver Ausgang der Datenspur
MDN1 DN1 MD1N DATA2_N DMO2N	MIPI 2nd negative Ausgabe der Datenspur
MDP1 DP1 MD1P DATA2_P DMO2P	MIPI 2nd positiver Ausgang der Datenspur
MDN2 DN2 MD2N DATA3_N DMO3N	MIPI 3rd negative Ausgabe der Datenspur
MDP2 DP2 MD2P DATA3_P DMO3P	MIPI 3rd positiver Ausgang der Datenspur
MDN3 DN3 MD3N DATA4_N DMO4N	MIPI 4th negative Ausgabe der Datenspur
MDP3 DP3 MD3P DATA4_P DMO4P	MIPI 4th positiver Ausgang der Datenspur
MCN CLKN CLK_N DCKN	MIPI Uhr negativer Ausgang
MCP CLKP MCP CLK_P DCKN	MIPI Takt positiver Ausgang
<b>DVP Parallel Schnittstelle</b>	
D0 DO0 Y0	DVP Datenausgabeport 0
D1 DO1 Y1	DVP Datenausgabeport 1
D2 DO2 Y2	DVP Datenausgabeport 2
D3 DO3 Y3	DVP Datenausgabeport 3
D4 DO4 Y4	DVP Datenausgabeport 4
D5 DO5 Y5	DVP Datenausgabeport 5
D6 DO6 Y6	DVP Datenausgabeport 6
D7 DO7 Y7	DVP Datenausgabeport 7
D8 DO8 Y8	DVP Datenausgabeport 8
D9 DO9 Y9	DVP Datenausgabeport 9
D10 DO10 Y10	DVP Datenausgabeport 10
D11 DO11 Y11	DVP Datenausgabeport 11

## Kamera-Zuverlässigkeitstest

Reliability Inspection Item		Testmethode	Akzeptanzkriterium	
Kategorie	Artikel			
Umwelt	Lager Temperatur	Hoch 60°C 96 Std	Temperaturkammer	Keine anormale Situation
		Niedrig -20°C 96 Std	Temperaturkammer	Keine anormale Situation
	Betriebs Temperatur	Hoch 60°C 24 Std	Temperaturkammer	Keine anormale Situation
		Niedrig -20°C 24 Std	Temperaturkammer	Keine anormale Situation
	Feuchtigkeit	60°C 80% 24 Std	Temperaturkammer	Keine anormale Situation
Thermischer Schock	Hoch 60°C 0.5 Std Niedrig -20°C 0.5 Std Radfahren rein 24 Std	Temperaturkammer	Keine anormale Situation	
Physisch	Falltest (Im freien Fall)	Ohne Verpackung 60cm	10 Mal auf Holzboden	Elektrisch funktionsfähig
		Mit Paket 60cm	10 Mal auf Holzboden	Elektrisch funktionsfähig
	Vibrations Test	50Hz X-Axis 2mm 30 Minuten	Vibrationstisch	Elektrisch funktionsfähig
		50Hz Y-Axis 2mm 30 Minuten	Vibrationstisch	Elektrisch funktionsfähig
		50Hz Z-Axis 2mm 30 Minuten	Vibrationstisch	Elektrisch funktionsfähig
Zugfestigkeit des Kabels Krafttest	Gewicht laden 4 kg 60 Sekunden Radfahren rein 24 Std	Zugprüfmaschine	Elektrisch funktionsfähig	
Elektrisch	ESD-Test	Kontaktaufnahme 2 KV	ESD-Prüfmaschine	Elektrisch funktionsfähig
		Luftentladung 4 KV	ESD-Prüfmaschine	Elektrisch funktionsfähig
	Alterungstest	On/Off 30 Sekunden Radfahren rein 24 Std	Stromschalter	Elektrisch funktionsfähig
	USB-Anschluss	On/Off 250 Mal	Einstecken und ausstecken	Elektrisch funktionsfähig





Inspektionsgegenstand		Untersuchungsmethode	Inspektionsstandard	
Kategorie	Artikel			
Aussehen	FPC oder PCB	Farbe	Das bloße Auge	Größere Unterschiede sind nicht zulässig.
		Zerrissen/gehackt werden	Das bloße Auge	Das Freilegen von Kupferrissen ist nicht zulässig.
		Markierung	Das bloße Auge	Klar, erkennbar (innerhalb von 30 cm Entfernung)
	Halterin	Kratzer	Das bloße Auge	Die Freilegung von Rissen im Inneren ist nicht zulässig
		Lücke	Das bloße Auge	Erfüllen Sie den Höhenstandard
		Schraube	Das bloße Auge	Stellen Sie sicher, dass Schrauben vorhanden sind (falls vorhanden)
		Schaden	Das bloße Auge	Die Freilegung von Rissen im Inneren ist nicht zulässig
	Linse	Kratzen	Das bloße Auge	Keine Auswirkung auf den Auflösungsstandard
		Kontamination	Das bloße Auge	Keine Auswirkung auf den Auflösungsstandard
		Ölfilm	Das bloße Auge	Keine Auswirkung auf den Auflösungsstandard
		Abdeckband	Das bloße Auge	Kein Problem beim Aussehen.
	Funktion	Bild	Keine Kommunikation	Testboard
Helles Pixel			Tafel	Im Image Center nicht erlaubt
Dunkles Pixel			Weißer Tafel	Im Image Center nicht erlaubt
Verschwommen			Das bloße Auge	Nicht erlaubt
Kein Bild			Das bloße Auge	Nicht erlaubt
Vertikale Linie			Das bloße Auge	Nicht erlaubt
Horizontale Linie			Das bloße Auge	Nicht erlaubt
Kleines Leck			Das bloße Auge	Nicht erlaubt
Blinkendes Bild			Das bloße Auge	Nicht erlaubt
Prellung			Inspektionslehre	Nicht erlaubt
Auflösung			Diagramm	Folgt dem Diagrammstandard für ausgehende Inspektionen
Farbe			Das bloße Auge	Kein Problem
Lärm			Das bloße Auge	Nicht erlaubt
Ecke dunkel			Das bloße Auge	Weniger als 100 x 100 Pixel
Farbauflösung			Das bloße Auge	Kein Problem
Abmessungen	Höhe	Das bloße Auge	Follows Approval Data Sheet	
	Breite	Das bloße Auge	Follows Approval Data Sheet	
	Länge	Das bloße Auge	Follows Approval Data Sheet	
	Gesamt	Das bloße Auge	Follows Approval Data Sheet	



## KLT-Paketlösungen

KLT Kameramodul



Komplett mit Linsenschutzfolie



Tablett mit Gitter und Raum



Legen Sie die Kameras auf das Tablett



## Paketlösung für Kameramodule

Volles Tablett mit Kameras



Abdeckschale mit Deckel



In Antistatikbeutel stecken



Staubsaugen Sie den antistatischen Beutel





## Paketlösung für Kameramodule

Versiegelter Vakuumbbeutel mit Etiketten

1. Modell und Beschreibung 2. Menge 3. Versanddatum 4. Achtung





## Paketlösung für große Bestellungen

Schaumstoffplatten zwischen  
die Tablettts legen



Schaumstoffplatten sind etwas  
größer als Tablettts



Legen Sie Schaumstoffplatten und  
Tablettts in die Schachtel



Schaumstoffplatten sind eng anliegende Box





## Paketlösung für kleine Bestellungen

Legen Sie die Schaumstoffplatten und  
Tablets in die kleine Schachtel



Schaumstoffplatten passen gut in  
die kleine Box



Paket in kleiner Box für den Versand



Legen Sie kleine Kartons in größere Kartons





## Carbon Box Paketlösung

Verschließen Sie die Carbonbox

Beschriftete Schachtel mit Endverpackung



### Versandfertige Karbonbox

1. Lieferadresse und Telefonnummer
2. Box-Nr. und Versanddatum
3. Zerbrechliche Vorsicht



## Lösung für Musterbestellungspakete

Legen Sie die Probe in einen kleinen antistatischen Beutel



Stecken Sie die Anschlüsse in den kleinen antistatischen Beutel



### Musteretiketten auf dem kleinen Beutel

1. Kameramodul oder Anschlussmodell 2. Lieferdatum und Menge 3. Achtung





## Connectors Large Order Package Solution

Steckverbinder in einem Rad



Steckverbinder im Rad beschriften



Das Rad passt perfekt in die Box



Steckerbox versandfertig



**Unternehmen Kai Lap Technologies (KLT)**

Kai Lap Technologies Group Limited. (KLT) wurde 2009 gegründet und ist ein technologiegetriebener Hersteller der nächsten Generation, der sich auf Forschung, Design und Produktion von Audio- und Videoprodukten spezialisiert hat. KLT verfügt über 20.000 Quadratfuß automatisierte Fabriken mit 100 Mitarbeitern und einem jährlichen Durchsatz von 30.000.000 Kameraeinheiten.

KLT bietet OEM-, ODM-Design, Auftragsfertigung und baut die Kameraprodukte. Sie können uns die Anforderungen auch mit einem Handentwurf übermitteln, unser Vertrieb und unsere Technik arbeiten zusammen, um Ihre Anforderungen zu erfüllen. Wir verstehen uns als Ihr langfristiger Partner bei der Entwicklung praktischer und innovativer Lösungen.

Unser Team deckt alles von der ersten Konzeptentwicklung bis zum Massenprodukt ab. KLT ist spezialisiert auf kundenspezifisches Kameradesign, Rohmaterial, Elektrotechnik, Firmware-/Softwareentwicklung, Produkttests und Verpackungsdesign. Unsere erfahrenen strategischen Versorgungssysteme bieten eine robuste und zuverlässige Fertigungskapazität für Aufträge unterschiedlicher Größe.

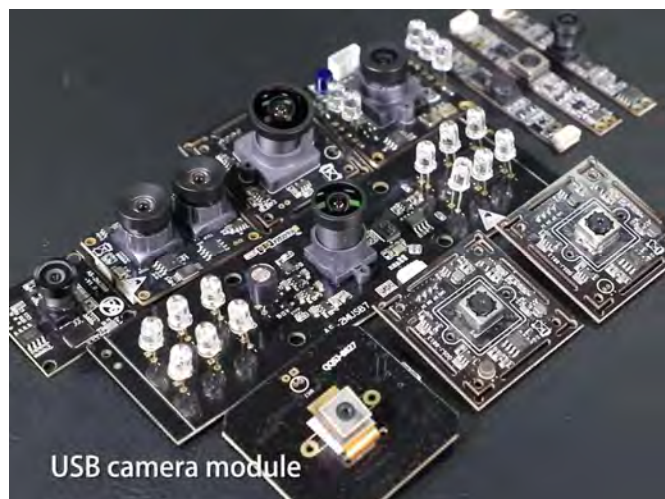
**Eingeschränkte Garantie**

KLT gewährt die folgende eingeschränkte Garantie, wenn Sie das/die Produkt(e) direkt von der Firma KLT oder von der Website von KLT, [www.KaiLapTech.com](http://www.KaiLapTech.com), gekauft haben. Produkte, die von anderen Verkäufern oder Quellen gekauft wurden, fallen nicht unter diese beschränkte Garantie. KLT garantiert, dass das/die Produkt(e) bei normalem Gebrauch für einen Zeitraum von einem (1) Jahr ab dem Datum, an dem Sie das Produkt erhalten („Garanzzeitraum“), frei von Material- und Verarbeitungsfehlern sind.

Für alle Produkte, die während des Garanzzeitraums Material- oder Verarbeitungsfehler enthalten oder entwickeln, wird KLT nach eigenem Ermessen entweder: (i) die Produkte reparieren; (ii) das/die Produkt(e) durch ein neues oder generalüberholtes Produkt(e) ersetzen (Ersatzprodukt(e) sind von identischem Modell oder funktionell gleichwertig); oder (iii) Ihnen den Preis erstatten, den Sie für das/die Produkt(e) gezahlt haben.

Diese eingeschränkte Garantie von KLT ist ausschließlich auf Reparatur und/oder Ersatz zu den oben genannten Bedingungen beschränkt. KLT ist nicht zuverlässig oder verantwortlich für nachfolgende Ereignisse.





*your BEST camera module partner*

## KLT Stärke

Leistungsstarke Fabrik



## Professioneller Service



## Versprochene Lieferung

